

Tuyaux articulés Ø 12 Gamme 1/2

ARROSEMENT MODULAIRE HP



Equipements complets Ø 12

Equipement **raccord 1/2"**, longueur 160 mm

CL1204

Equipement **raccord 3/8"**, longueur 160 mm

CL1206

- 1 raccord NPT
- 1 segment M
- 1 segment S
- 1 buse ronde Ø 10 mm
- 1 écrou

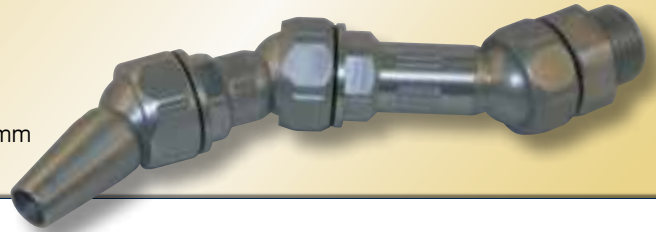

HP MAX
80 bar

Montage des Buses

Toute nouvelle buse doit être fixée avec un écrou CL1282, une buse de remplacement peut utiliser l'écrou en place.



Segments Ø 12

Segment S

- 1 segment
- 3 segments



Réf.
CL1210
CL1211

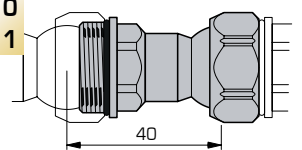

Segment M

- 1 segment
- 2 segments



CL1214
CL1215

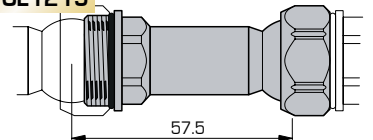

Segment L

- 1 segment

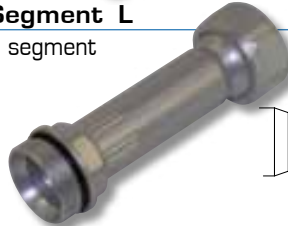

CL1218

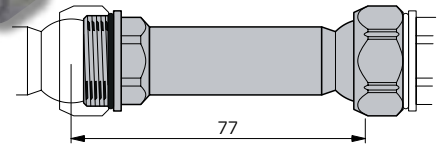

Buses Droites Ø 12

Buse ronde

- 1 buse Ø 6 mm



Réf.
CL1222

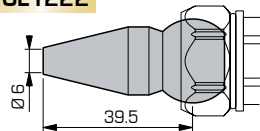

Buse ronde

- 1 buse Ø 8 mm



CL1224

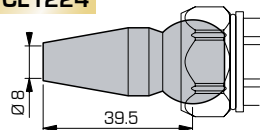

Buse ronde

- 1 buse Ø 10 mm



CL1226

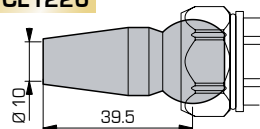

Buse ronde

- 1 buse
- 19 trous Ø 2



CL1228

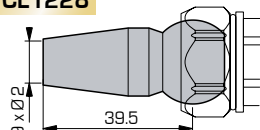

Jet puissant et précis

Raccord	NPT 60° Ø - filets/pouce	BSP T (gaz) 55° Ø - filets/pouce
3/8"	17,3 mm - 18	16,5 mm - 19
1/2"	21 mm - 14	21 mm - 14

Raccords filetés Ø 12

Raccord NPT

- 1 Raccord 3/8



Réf.
CL1262

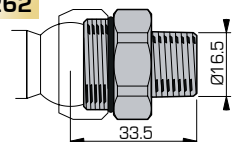

Raccord NPT

- 1 Raccord 1/2



CL1266

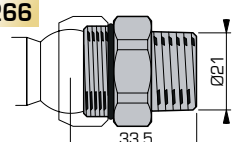

Raccord BSPT Cylindrique

- 1 Raccord 3/8



CL1264

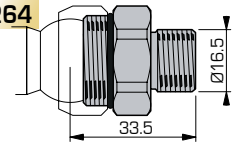

Raccord BSPT Cylindrique

- 1 Raccord 1/2



CL1268

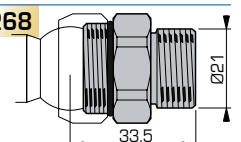

Tuyaux articulés Ø 12 Gamme 1/2

Buses Coudées Ø 12

Buse coudée à 90° courte

1 buse
7 trous Ø 2.5 mm

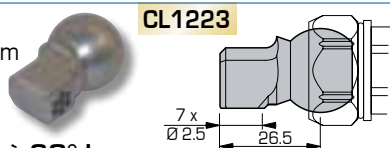

CL1223

Buse coudée à 90° longue

1 buse
7 trous Ø 2.5 mm

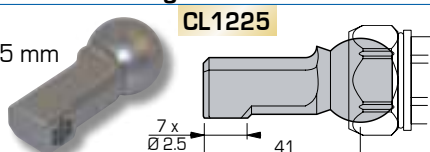

CL1225

Buse coudée à 60° courte

1 buse
7 trous Ø 2.5 mm

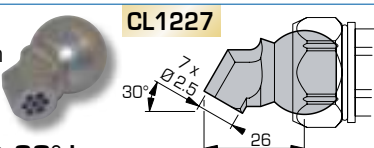

CL1227

Buse coudée à 60° longue

1 buse
7 trous Ø 2.5 mm

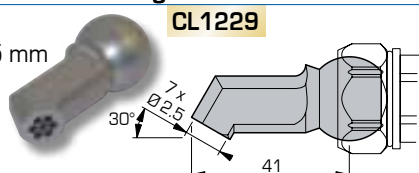

CL1229

Les Buses Multi-jets

 assurent un jet précis même sur une longue distance.



Buses Plates

Avec un écrou CL 1282.

1 Buse plate

largeur 30
largeur 40
largeur 50
largeur 60
largeur 80
largeur 100
largeur 120

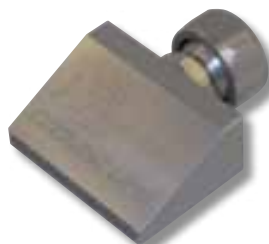

Réf.

CL1230
CL1231
CL1232
CL1233
CL1234
CL1236
CL1238

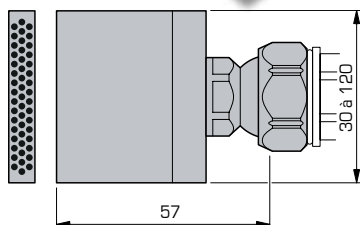

KOPAL

Robinet Ø 12

Robinet

1 sortie ligne

CL1250

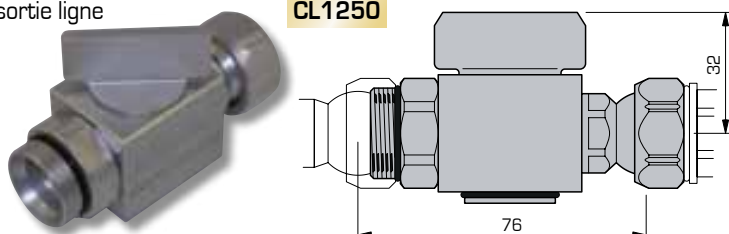

Pièces de liaison Ø 12

Coude

1 sortie à 90°



Réf.

CL1242

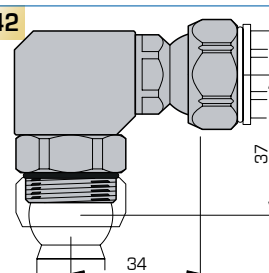

Distributeur en Té

2 sorties à 180°



CL1244

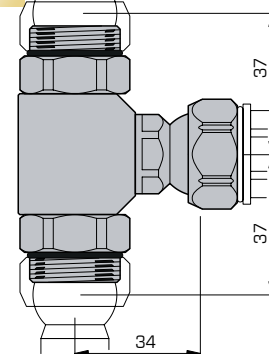

Distributeur en Y à 90°

2 sorties Ø 12
vers Ø 12

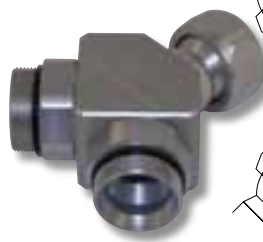

CL1248

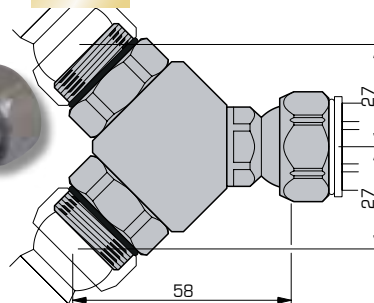

Distributeur en Y à 90°

2 sorties Ø 12
vers Ø 5.5



CL1246

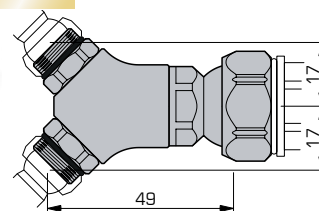

Accessoires Ø 12

Écrou Ø 12

1 écrou pour buse

Réf.

CL1282



Joint Ø 12

1 joint torique

Réf.

CL1284



Clé de serrage

1 clé plate 21 et 27 mm

Réf.

CL1290

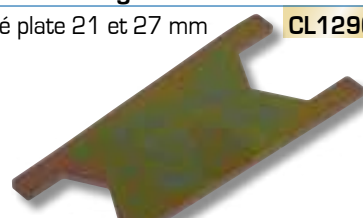

KOPAL 51

ARROSAGE MODULAIRE HP